

h

mmunicatio

**OPERATING and SERVICE
INSTRUCTIONS**

**S-53A
&
S-53AU
RUN 2**

the hallicrafters co.

MANUFACTURERS OF RADIO AND ELECTRONIC EQUIPMENT, CHICAGO 24, U. S. A.

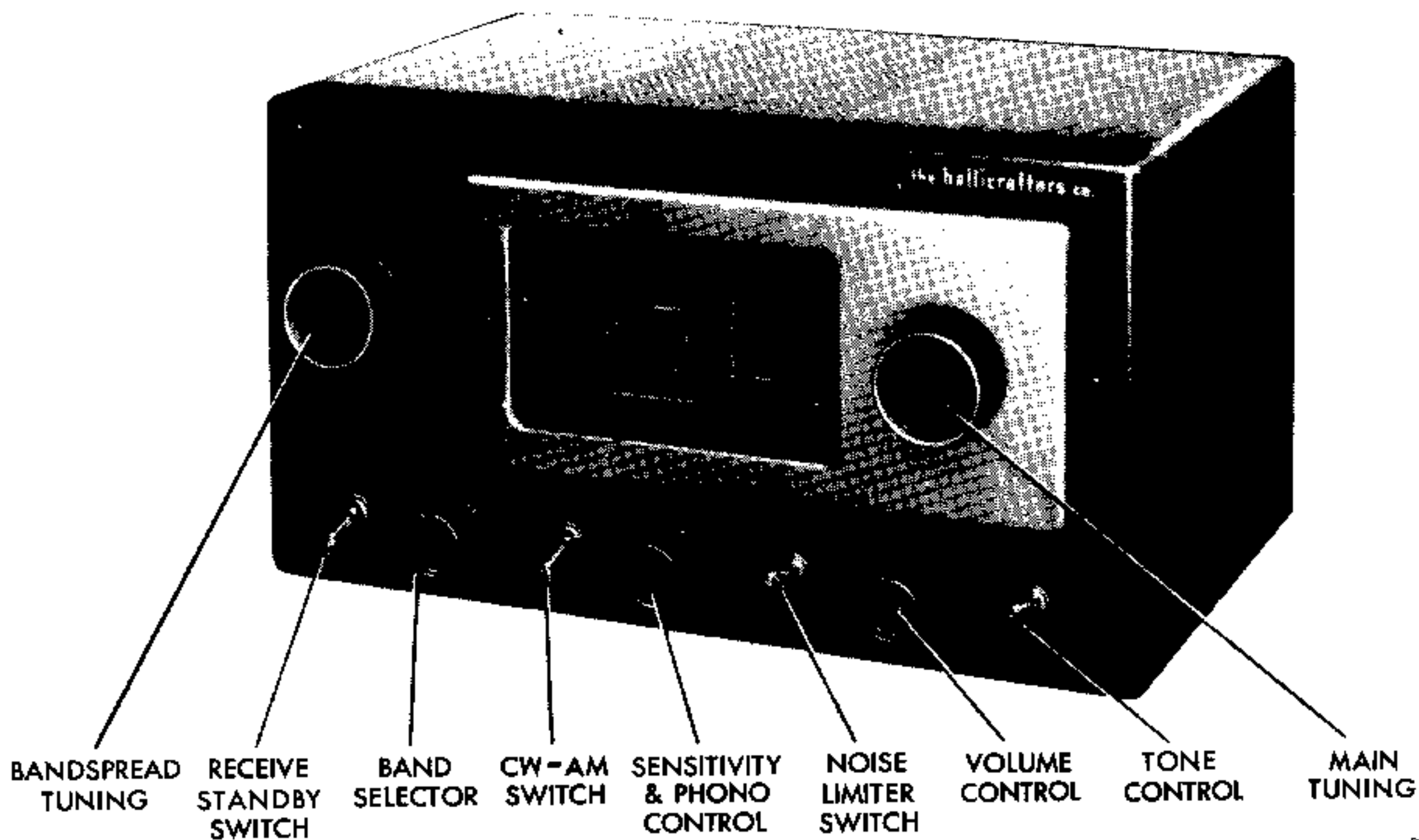

Fig. 1. Models S-53A and S-53AU

92X495-A

DESCRIPTION

Hallicrafters Models S-53A and S-53AU are sensitive superheterodyne radio receivers which provide standard broadcast and shortwave reception over five frequency ranges with coverage from 540 KC to 1630 KC, 2.5 MC to 31 MC and 48 MC to 54.5 MC. The receivers employ seven tubes plus rectifier and provide reception of both AM and CW signals.

The S-53A is designed to operate from a 105-125 volt 50-60 cycle AC power source. The S-53AU, the universal model of the S-53A, can be operated from 25-60 cycle AC sources at voltages ranging from 110 to 250 volts.

The BANDSPREAD control which is specifically calibrated for band E (48 MC - 54.5 MC) also serves as a fine tuning adjustment for bands A, B, C, and D.

FREQUENCY COVERAGE

BAND	FREQUENCY RANGE
A	540 KC - 1630 KC
B	2.5 MC - 6.3 MC
C	6.3 MC - 16 MC
D	14 MC - 31 MC
E	48 MC - 54.5 MC

The receiver is equipped with a built-in 5 inch permanent magnet speaker. For those desiring headphone operation, tip jacks have been provided at the rear of the chassis for connection to the headphones.

The RECEIVE/STANDBY switch permits disabling of the receiver for standby periods, the tube heaters being maintained at operating temperature for immediate operation when reception is again desired.

Other special features incorporated in the receiver include an automatic noise limiter, a sensitivity or RF gain control, a two position tone control and a phono jack for attachment of a record player.

Before connecting the receiver to the power source, carefully read the INSTALLATION INSTRUCTIONS which follow.

INSTALLATION INSTRUCTIONS

UNPACKING - Check all shipping tags and labels for instructions before removing or destroying them.

LOCATION - The receiver is equipped with rubber feet for table top or shelf mounting. When locating the receiver, avoid excessively warm locations. Allow at least an inch of clearance between the back of the receiver and the wall for proper ventilation.

POWER SOURCE - The S-53A is designed to operate from a 105-125 volt 50-60 cycle AC source. The universal model, the S-53AU, is designed for operation from 110, 130, 150, 220 and 250 volt 25-60 cycle AC sources. A selector switch located on the power transformer permits operation of the S-53AU on any of the line voltages indicated. The power consumption of each model is 50 watts. If in doubt as to the frequency or voltage rating of your power source, contact your local power company to avoid damage to the receiver.

CAUTION - Before connecting the S-53AU to a power source, it is essential that the selector switch setting on the power transformer correspond to the operating line voltage.

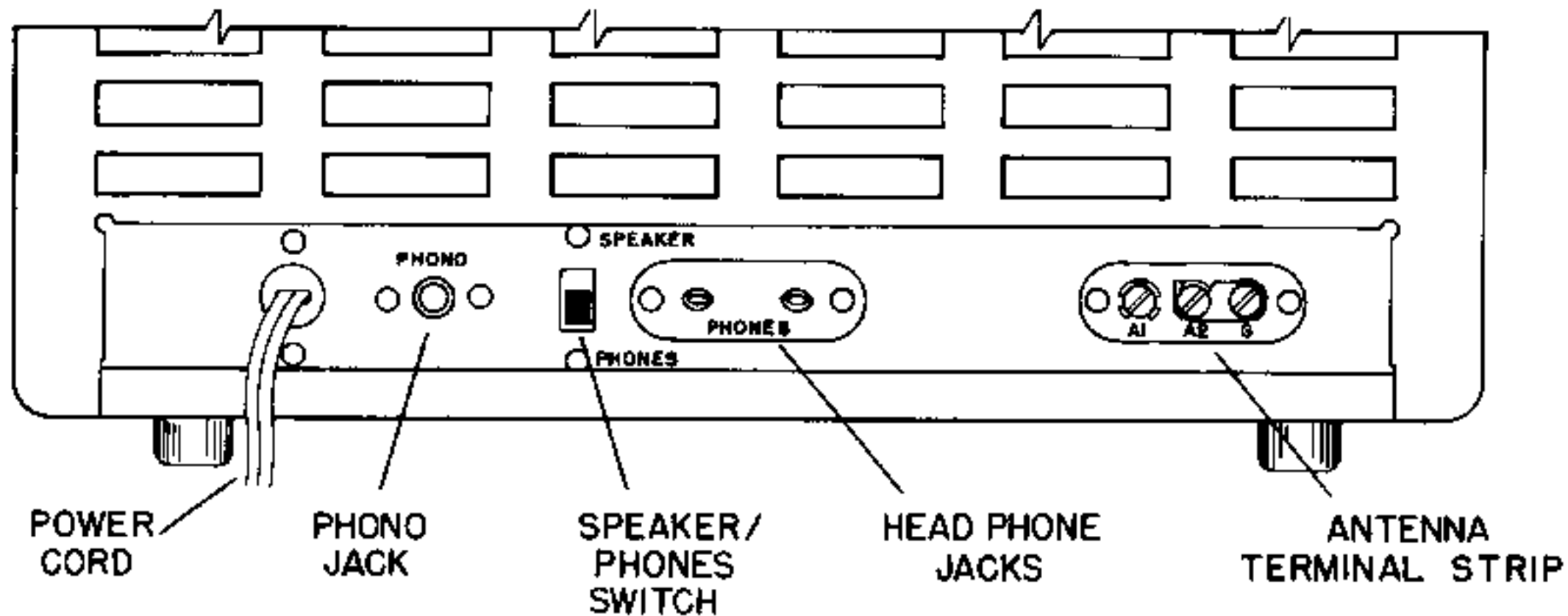

Fig. 2. Rear View of Cabinet

920385-A

ANTENNA - A three terminal strip is provided at the rear of the chassis for antenna connections. The terminals are marked A1, A2, and G. Very satisfactory results can be obtained throughout the tuning range of the receiver with a conventional single wire antenna. In some instances, a short length of wire strung about the room may suffice. However, it is recommended that a doublet antenna installation be employed on the shortwave bands for improved reception. For further information on antennas, refer to the "ARRL ANTENNA HANDBOOK".

SINGLE WIRE ANTENNA

1. Construct the antenna as shown in Fig. 3 and connect it to A1.
2. Connect the jumper between A2 and G.
3. Erect the antenna as high as possible and free of surrounding objects.
4. In some instances, a wire connected between G and a suitable ground such as a cold water pipe or outside ground rod may improve reception.

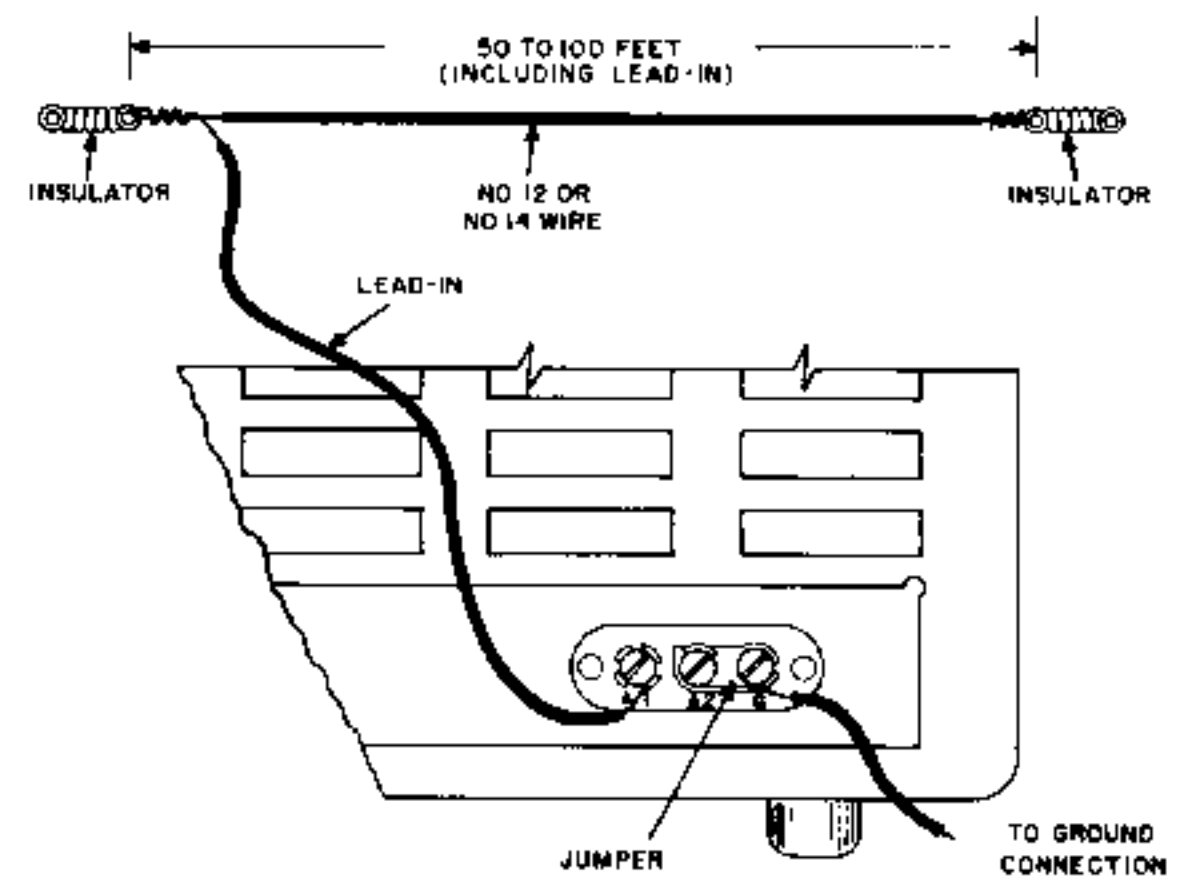

Fig. 3. Single Wire Antenna Installation 9281550

DOUBLET ANTENNA

1. The overall length (in feet) of the antenna is determined by dividing 468 by the frequency (in megacycles) at the high end of the range to which you wish to listen.
2. Construct the antenna as shown in Fig. 4.
3. A doublet antenna is directional broadside to its length and should be so oriented with respect to a desired station for maximum signal pickup.
4. When feeding the antenna with a twisted pair or ribbon type transmission line, connect the line to A1 and A2 and disconnect the jumper between A2 and G.
5. When feeding the antenna with a coaxial transmission line, connect the inner conductor to A1, and the outer conductor to A2. Connect the jumper between A2 and G.
6. See step 4 under SINGLE WIRE ANTENNA.

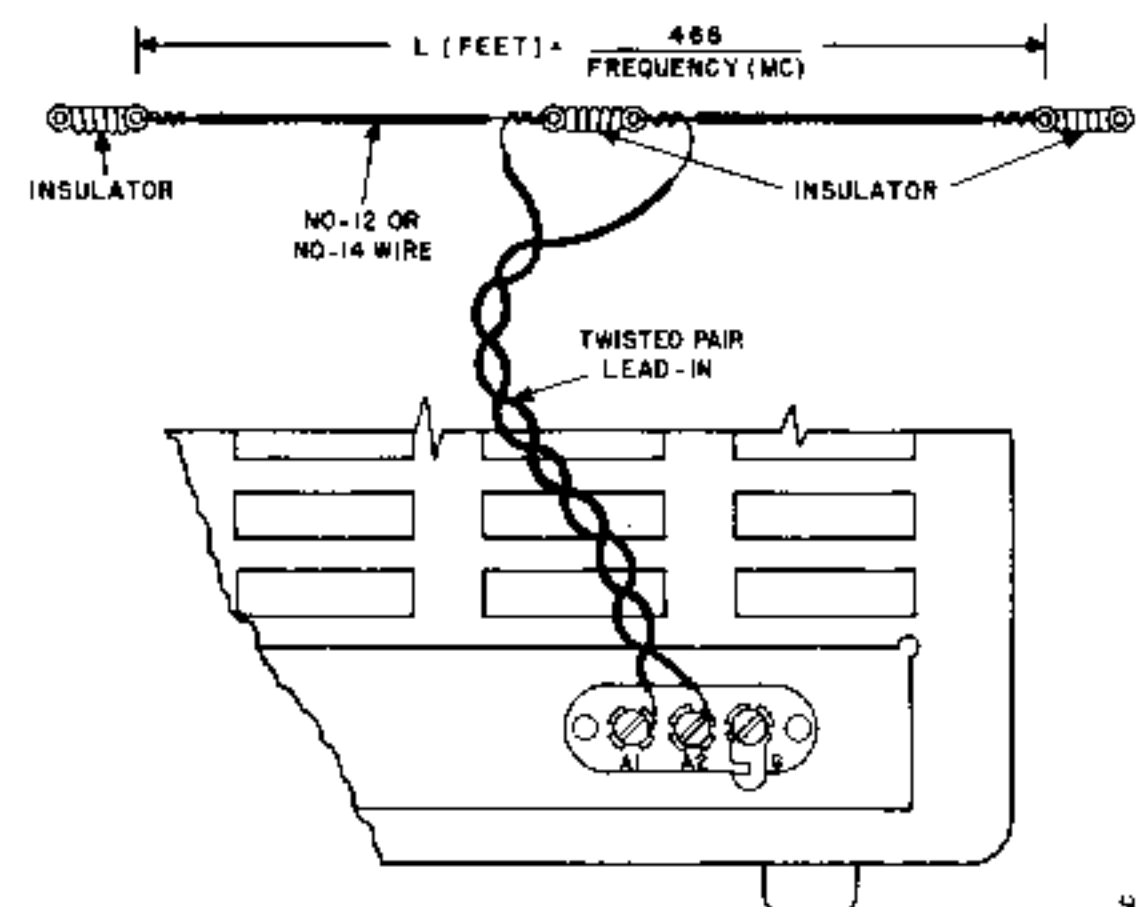

Fig. 4. Doublet Antenna Installation Using Twisted Pair Lead-In

9281551

OPERATING INSTRUCTIONS

AM AND CW RECEPTION

NOTE: The control positions for standard broadcast reception (band A) are marked in RED for convenience to the listener:

1. Set the BAND SELECTOR for the desired frequency range or band. The five positions of the BAND SELECTOR correspond to the band letters at either end of the dial.
2. Set the CW/AM switch at AM for voice reception or at CW for code reception.
3. Set the RECEIVE/STANDBY switch at RECEIVE. When set at STANDBY, the receiver is inoperative but the tube heaters remain at operating temperature for instant use.
4. Set the SPEAKER/PHONES switch which is located at the rear of the chassis to SPEAKER.
5. Turn the SENSITIVITY control fully clockwise. When strong code signals block the receiver, reduce the sensitivity slightly by turning the control counterclockwise.
6. Turn the receiver ON by rotating the VOLUME control clockwise. This control will have to be reset for the desired volume level after the station has been tuned in. Turning the control clockwise increases volume.
7. TUNING OF BANDS A, B, C, D - Set the BANDSPREAD dial pointer at 100. Tune in the desired station with the TUNING control (Fig. 1). For code (CW) reception, adjust the TUNING control for the desired pitch of the code signal when tuning.
TUNING OF BAND E - Set the TUNING dial pointer at the right hand index mark on the dial. Tune in the desired station with the BANDSPREAD control. For code (CW) reception, adjust the BANDSPREAD control for the desired pitch of the code signal when tuning.

IMPORTANT - The station frequency readings on bands A, B, C and D will be correct only if the BANDSPREAD dial pointer is set at 100. The readings on band E will be correct only if the TUNING dial pointer is set at the right hand index mark.

8. For fine tuning of bands A, B, C and D, refer to BANDSPREAD TUNING below.
9. For voice (AM) reception, set the TONE switch for the desired response. For code (CW) reception, set the switch at LOW.
10. Normally set the NOISE LIMITER switch at OFF. If severe electrical disturbances interfere with reception, set the switch at ON.
11. To turn the receiver OFF, rotate the VOLUME control counterclockwise to the OFF position.

BANDSPREAD TUNING

1. To use the BANDSPREAD control for fine tuning of bands A, B, C and D: (1) Set the BANDSPREAD dial pointer at 100 (2) Set the TUNING dial pointer at the high frequency end of the amateur band or group of stations to be covered and (3) Tune in the stations with the BANDSPREAD control.
2. The BANDSPREAD control also functions as the main tuning adjustment for band E. See step 7 above.
3. It is possible to log stations of special interest by recording the settings of the TUNING and BANDSPREAD dial pointers. See inside of back cover for the station log.

RECORD PLAYER OPERATION

1. A shielded type receptacle marked PHONO is provided at the rear of the chassis to accommodate any record player using a crystal pickup.
2. Connect the record player to the receiver as shown in Fig. 5.
3. Set the SELECTIVITY control at PHONO and the RECEIVE/STANDBY switch at RECEIVE.
4. Operate the VOLUME control and the TONE switch as explained under AM AND CW RECEPTION.

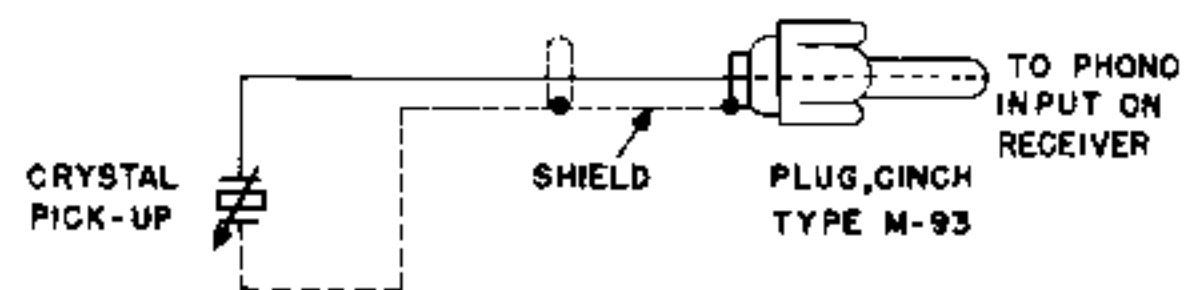

9281395-B

Fig. 5. Wiring Diagram for Record Player Connection

HEADPHONE OPERATION

1. Tip jacks are provided at the rear of the chassis for headphone connection.
2. Any standard pair of headphones with an impedance of 500 to 3000 ohms can be used with the receiver.
3. For headphone operation, set the SPEAKER/PHONES switch located at the rear of the chassis to PHONES.

SERVICE INSTRUCTIONS

GENERAL SPECIFICATIONS

Tubes	Seven plus rectifier
Speaker	5 inch PM
Voice Coil Impedance	3.2 ohms
Headphone Output Impedance	15 ohms
Antenna	Provision for single wire or doublet
Phono Input Impedance	High impedance
Intermediate Frequency	455 KC
S-53A Operating Voltage	105-125 volts 50-60 cycles AC
S-53AU Operating Voltage	105-250 volts 25-60 cycles AC
Power Consumption	50 watts
Frequency Coverage	See page 2

TUBE REPLACEMENT- The tube types and their relative location in the receiver are shown in Fig. 8. To gain access to all tubes, open the hinged top cover of the cabinet. When installing a replacement octal tube: (1) Insert the center guide pin of the tube into the center hole of the tube socket (2) Rotate the tube until the key on the guide pin drops into the notch in the socket hole and (3) Push down on the tube until the base of the tube rests firmly on the socket. When installing a replacement miniature tube, line up the seven pins on the tube with the socket holes before pushing the tube into place. Handle all tubes with care as they are fragile and will not withstand mechanical abuse.

DIAL LAMP REPLACEMENT- Refer to Fig. 8 for the location of the dial lamps used in the receiver. To gain access to the dial lamps, open the hinged top cover of the cabinet. Unclip the dial lamp socket from the mounting bracket. The socket and lamp can then be brought out into the open. Make replacement with a 6-8 volt, 250 ma Mazda #44 pilot lamp or equivalent.

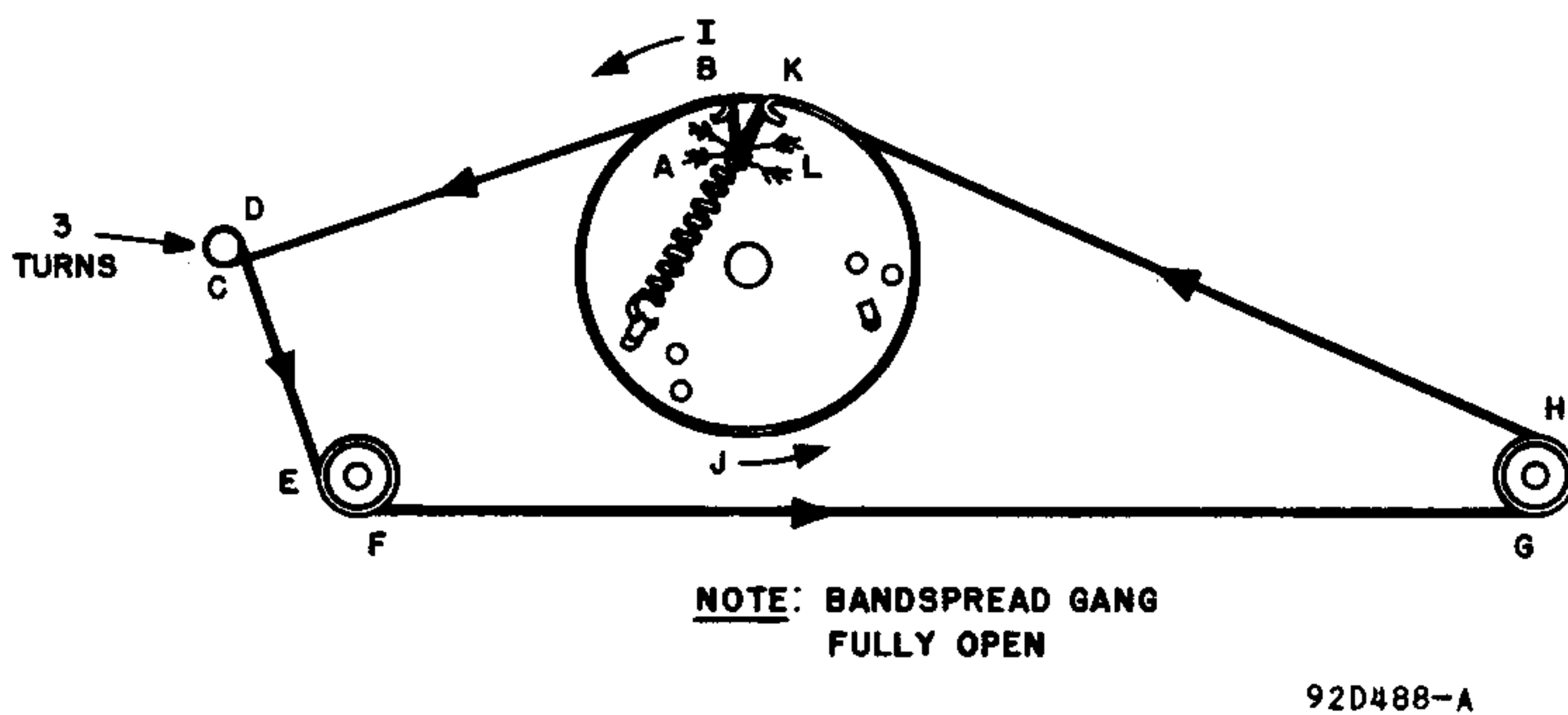

Fig. 6. BANDSPREAD Dial Cord Stringing Diagram

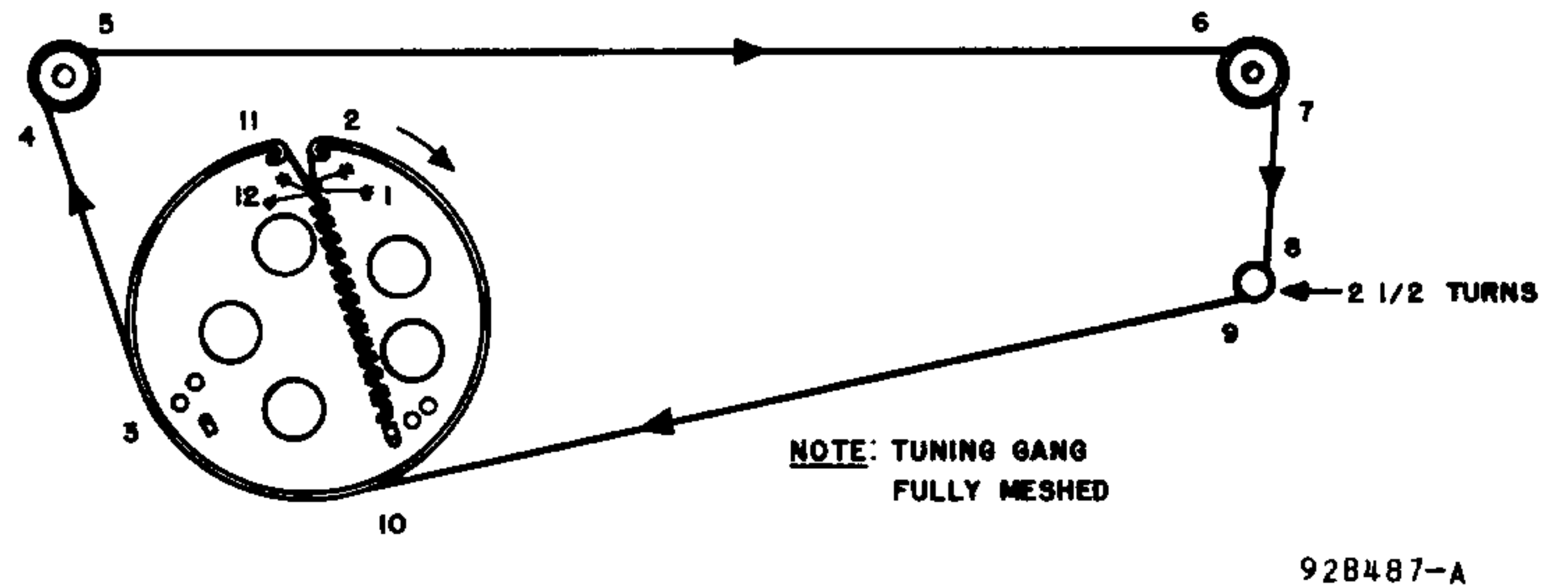

Fig. 7. TUNING Dial Cord Stringing

DIAL CORD RESTRINGING

BANDSPREAD DIAL

1. Set the BANDSPREAD gang fully open.
2. Tie one end of a 36 inch length of 30 lb. test dial cord to the spring at position A. See Fig. 6.
3. Follow the stringing procedure A thru L.
4. At position L, stretch the spring and tie the cord securely to the spring.
5. With the BANDSPREAD gang fully open, attach the dial pointer to the cord and align it with 100 on the LOGGING SCALE.

TUNING DIAL

1. Set the TUNING gang fully closed.
2. Tie one end of a 48 inch length of 30 lb. test dial cord to the spring at position 1. See Fig. 7.
3. Follow the stringing procedure 1 thru 12.
4. At position 12, stretch the spring and tie the cord securely to the spring.
5. With the TUNING gang fully closed, attach the dial pointer to the cord and align it with the left hand index marks.

SERVICE OR OPERATING QUESTIONS - For further information regarding operation or servicing of the receiver, contact your dealer. Make no shipments to the factory as the factory will not accept the responsibility for unauthorized shipments. Factory type service is available at any **HALLICRAFTERS AUTHORIZED SERVICE CENTER** which displays the sign shown at the right. For the location of the **SERVICE CENTER** nearest you, consult your dealer or telephone directory.

The Hallicrafters Company reserves the privilege of making revisions in current production of equipment and assumes no obligation to incorporate these revisions in earlier models.



ALIGNMENT PROCEDURE

- Remove chassis from cabinet for alignment by removing three screws at bottom edge of both front panel and rear of cabinet and two screws at each side of front panel.
- Use signal generator with modulated output covering 455 KC to 52 MC.
- Use a non-metallic alignment tool.

- Connect output meter across speaker voice coil terminals.
- Control settings: STANDBY/RECEIVE at RECEIVE, CW/AM at AM, NOISE LIMITER at OFF, TONE at HIGH, SPEAKER/PHONES at SPEAKER and SENSITIVITY, VOLUME and BANDSPREAD fully clockwise.
- See Fig. 9 for location of alignment adjustments.

STEP	SIGNAL GENERATOR CONNECTIONS	SIGNAL GENERATOR FREQUENCY	BAND SELECTOR SETTING	RECEIVER DIAL SETTING	ADJUST	INSTRUCTIONS
1	High side to stator plates of front section of tuning gang through a .1 mfd. capacitor. Low side to chassis.	455 KC	A	TUNING gang fully open.	S1, S2, S3, S4, S5, S6	Adjust for maximum audio output at the speaker voice coil. Use just enough signal generator output to obtain a 50 milliwatt reading on the output meter.
2	Same as STEP 1.	455 KC	A	Same as STEP 1.	S9	Set the CW/AM switch at CW. (Reset the switch to AM when STEP 2 is completed.) Adjust S9 for a zero beat.
3	High side to A1 on antenna terminal strip through a 330 ohm resistor. Low side to chassis. Connect the jumper between A2 and G.	1500 KC 600 KC	A A	1.5 MC .6 MC	A,B C	Maximum output as in STEP 1.
4	Same as STEP 3.	6 MC	B	6 MC	D,E	Maximum output as in STEP 1.
5	Same as STEP 3.	15 MC	C	15 MC	F,G	Maximum output as in STEP 1.
6	Same as STEP 3.	30 MC	D	30 MC	I,H	Maximum output as in STEP 1.
7	Same as STEP 3.	52 MC	E	52 MC	J,K	Maximum output as in STEP 1.

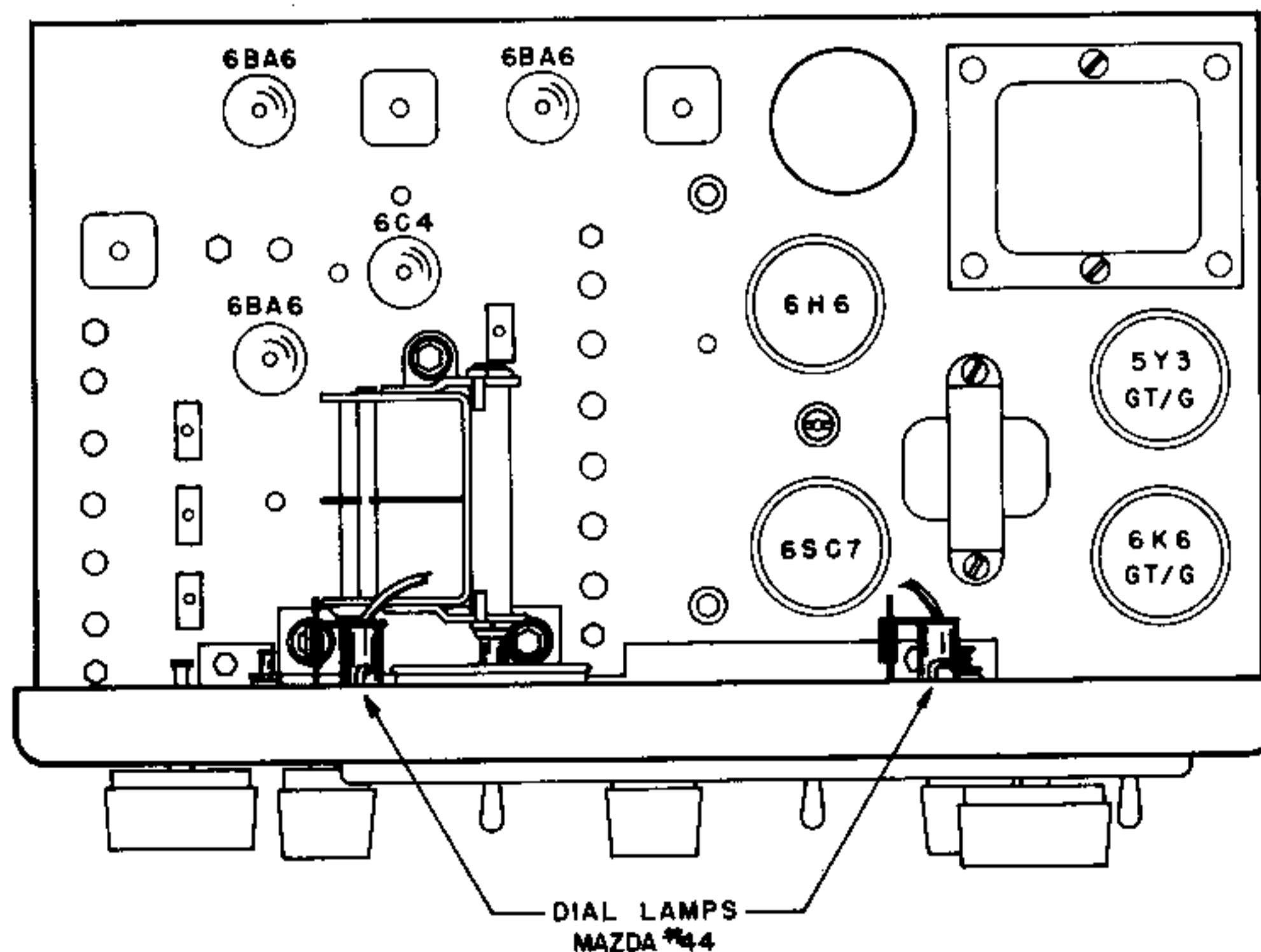
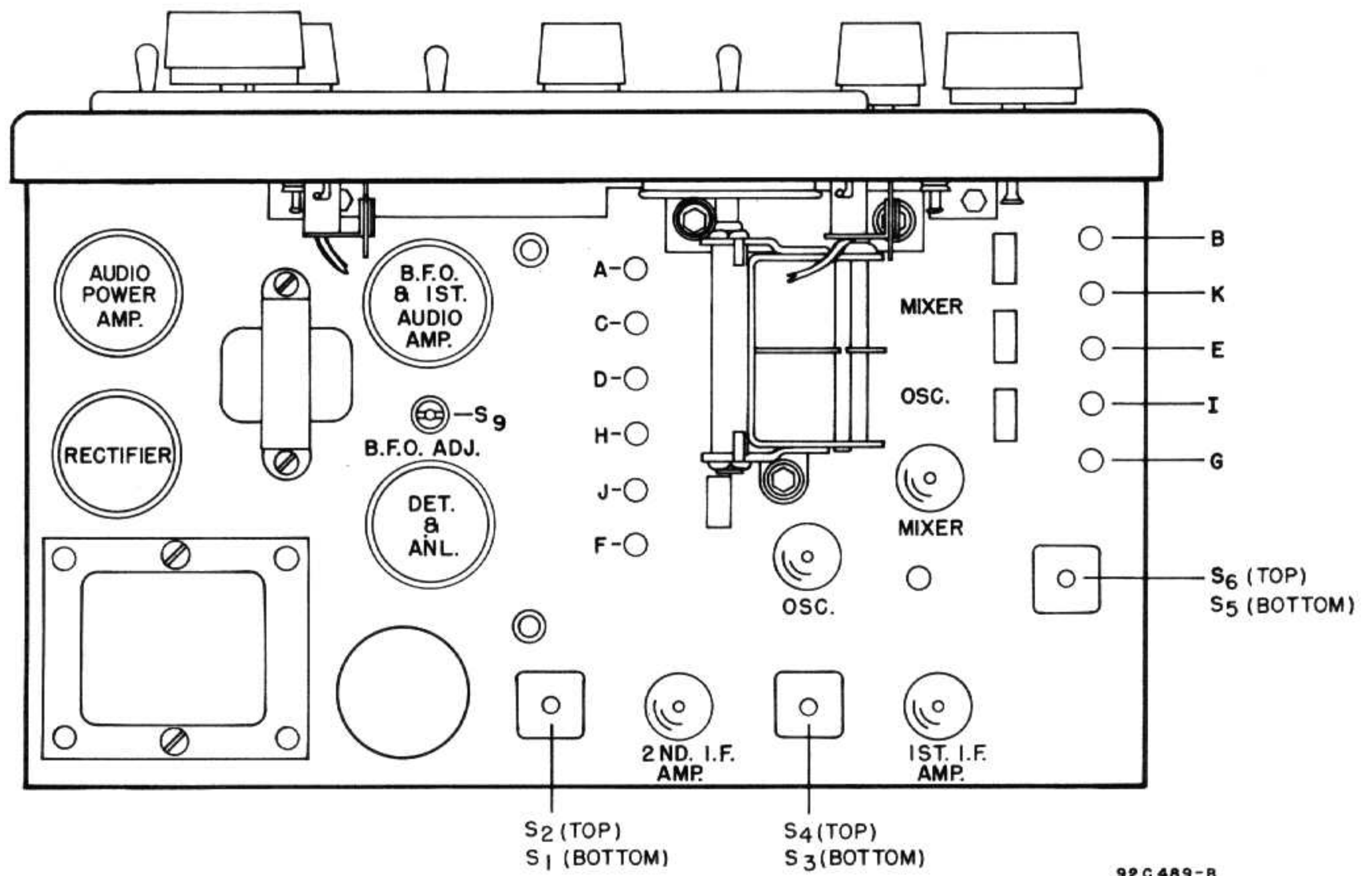

Fig. 8. Top View of Chassis Showing Location of Tubes and Dial Lamps

92C1092-A



92C 489-B

Fig. 9. Top View of Chassis Showing Location of Alignment Adjustments

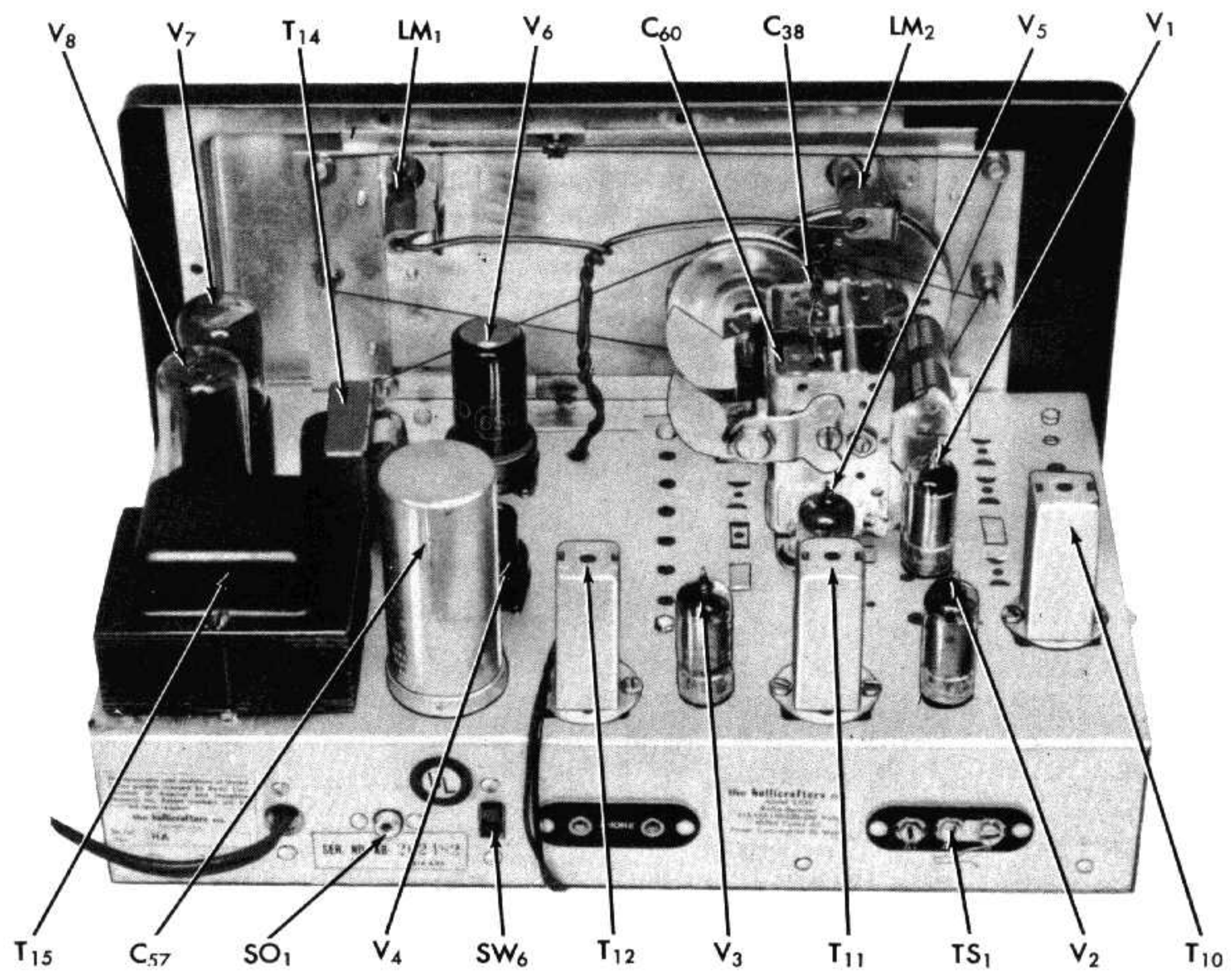

92X1103-A

Fig. 10. Top View of Chassis Showing Component Location

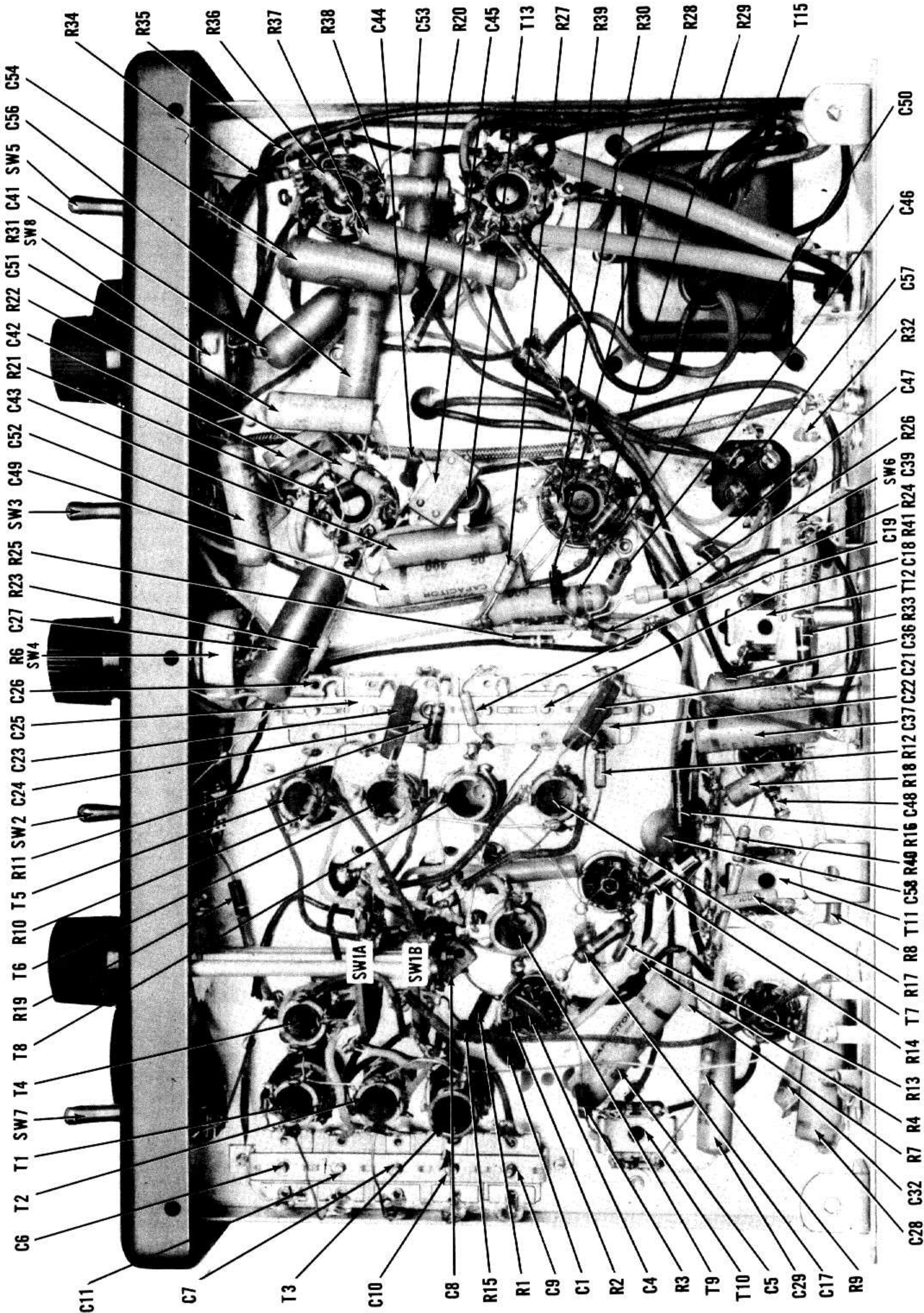

C6 T2 T1 SW7 T4 T8 R19 T6 R10 T5 R11 SW2 C24 C23 C25 C26 R6 C27 R23 R25 SW3 C49 C52 C43 R21 C42 R22 C51 R31 C41 SW5 C56 C54
 SW8
 SW4
 SW6
 SW6

C28 C32 R7 R4 R13 R14 T7 R17 R8 T11 C58 R40 R16 C48 R18 R12 C37 C22 C21 C36 R33 T12 C18 R41 R24 C39 R26 C47 R32 C57 C46 C50
 R34 R35 R36 R37 R38 C44 C53 R20 C45 T13 R27 R39 R30 R28 R29 T15

Fig. 11. Bottom View of Chassis Showing Component Location

SERVICE PARTS LIST

Schematic Symbol	Description	Hallicrafters Part Number	Schematic Symbol	Description	Hallicrafters Part Number
CAPACITORS			COILS AND TRANSFORMERS (Cont.)		
C-1,4,58	.005 mfd. 450 V., ceramic	47A168	T-9	Coil, oscillator; band E	51B1239
C-5,39,49	.05 mfd. 400 V., tubular	46AW503J	T-10,11	Transformer, 1st and 2nd IF	50C241
C-6,7,9,10,11	Trimmer assembly, 5 sections, antenna stage	44B355	T-12	Transformer, 3rd IF	50C242
C-8,42	220 mmf. 500 V., mica	47X20B221K	T-13	Coil, BFO	54B043
C-17,40,44	100 mmf. 500 V., ceramic	47A086	T-14	Transformer, audio output	55B107
C-18,19,22,24,25,26	Trimmer assembly, 6 sections, oscillator stage	44B388	T-15	Transformer, power; model S-53A	52C164
C-21	2400 mmf. 500 V., silver mica	47X20C242J	T-15	Transformer, power; model S-53AU	52C165
C-23	1800 mmf. 2% 500 V., silver mica	47X20C182G	SWITCHES		
C-27	.1 mfd. 200 V., tubular	46AU104J	SW-1	BAND SELECTOR switch assembly	60B323
C-28,38,54	.02 mfd. 600 V., tubular	46AY203J	SW-2	Switch, dpst; CW/AM	60A285
C-29,32,37,43,50,52,53,56	.01 mfd. 600 V., tubular	46AZ103J	SW-3,5,7	Switch, spst; STANDBY/RECEIVE, NOISE LIMITER and TONE	60A138
C-38	2.2 mmf. 500 V., ceramic	47A160-4	SW-4	Switch, PHONO; part of SENSITIVITY control R-6	-----
C-41	.01 mfd. 600 V., molded paper	46AC103J	SW-6	Switch, spdt; SPEAKER/PHONES	60A243
C-45	470 mmf. 500 V., mica	47X20B471J	SW-8	Switch, OFF-ON; part of VOLUME control R-31	-----
C-46,47	50 mmf. 500 V., ceramic	47A091	PLUGS AND SOCKETS		
C-48	5 mmf. 500 V., ceramic	47X20UK050K	PL-1	Line cord and plug	87A078
C-51	.003 mfd. 600 V., tubular	46AZ302J	SO-1	PHONO jack	36A041
C-57	50-10-10 mfd. 350 V., 10 mfd. 25V.; electrolytic	45B122	SO-2	PHONE jacks	88A071
C-60 A,B	Tuning capacitor, 2 section.	48C198		Socket, dial lamp; includes lead	86B063
RESISTORS				Socket, tube; octal	6A296
R-1,24	1.8 megohms 1/2 watt, carbon	23X20X185M		Socket, tube; miniature 7 pin	6A297
R-2	2200 ohms 1/2 watt, carbon	23X20X222M	TUBES AND DIAL LAMPS		
R-3,15	27 ohms 1/2 watt, carbon	23X20X270M	V-1,2,3	6BA6: mixer, 1st IF amplifier and 2nd IF amplifier	90X6BA6
R-4,27	330,000 ohms 1/2 watt, carbon	23X20X334K	V-4	6H6: detector and ANL	90X6H6
R-6	10,000 ohms, SENSITIVITY control; includes switch SW-4	25B603	V-5	6C4: oscillator	90X6C4
R-7,17	100 ohms 1/2 watt, carbon	23X20X101K	V-6	6SC7: audio amplifier and BFO	90X6SC7
R-8,16,34	1000 ohms 1/2 watt, carbon	23X20X102M	V-7	6K6-GT: audio output	90X6K6-GT
R-9,30,32,36	470,000 ohms 1/2 watt, carbon	23X20X474M	V-8	5Y3-GT: rectifier	90X5Y3-GT
R-10	15,000 ohms 1/2 watt, carbon	23X20X153K	LM-1,2	Lamp, pilot; 6-8 volt, 250 ma. Mazda #44	39A003
R-11	10,000 ohms 1/2 watt, carbon	23X20X103K	MISCELLANEOUS PARTS		
R-12	4700 ohms 1/2 watt, carbon	23X20X472K	Cabinet; does not include top cover, front panel or escutcheon		
R-13,23	22,000 ohms 1/2 watt, carbon	23X20X223M	Clip, coil mtg.		
R-14	10,000 ohms 1 watt, carbon	23X30X103K	Clip, dial glass mtg.		
R-18	22,000 ohms 1 watt, carbon	23X30X223M	Clip, mtg.; for IF transformers T-10, 11 and 12		
R-19	120 ohms 1/2 watt, carbon	23X20X121M	Dial cord, 60 inch		
R-20	220,000 ohms 1/2 watt, carbon	23X20X224K	Dial scale, glass		
R-21	15 megohms 1/2 watt, carbon	23X20X156K	Escutcheon, front panel		
R-22,26	47,000 ohms 1/2 watt, carbon	23X20X473M	Front panel, cabinet; does not include escutcheon		
R-25	100,000 ohms 1/2 watt, carbon	23X20X104K	Grommet, rubber		
R-28,40	1 megohm 1/2 watt, carbon	23X20X105M	Knob, BAND SELECTOR, SENSITIVITY and VOLUME		
R-29	2.7 megohms 1/2 watt, carbon	23X20X275M	Knob, BANDSPREAD and TUNING		
R-31	2 megohms, VOLUME control; includes switch SW-8	25B602	Lock, line cord		
R-33	15 ohms 1/2 watt, carbon	23X20X150M	Mounting foot, rubber		
R-35	680 ohms 1/2 watt, carbon	23X20X681K	Pad, dial clip		
R-37	680 ohms 2 watts, carbon	23X40X681M	Pointer, BANDSPREAD dial		
R-38	1000 ohms 1 watt, carbon	23X30X102M	Pointer, TUNING dial		
R-39	6.8 ohms 1 watt, carbon	23X30X068K	Shaft, tuning		
R-41	3300 ohms 1/2 watt, carbon	23X20X332K	LS-1	Speaker, 5 inch PM	85C030
COILS AND TRANSFORMERS			TS-1	Spring, dial cord	75A012
T-1	Coil, antenna; band A	51B1028		Terminal strip, antenna	88A032
T-2	Coil, antenna; band B	51B1244		Top cover, cabinet	66D436
T-3	Coil, antenna; bands C and D	51B1026			
T-4	Coil, antenna; band E	51B1030			
T-5	Coil, oscillator; band A	51B1235			
T-6	Coil, oscillator; band B	51B1236			
T-7	Coil, oscillator; band C	51B1237			
T-8	Coil, oscillator; band D	51B1238			

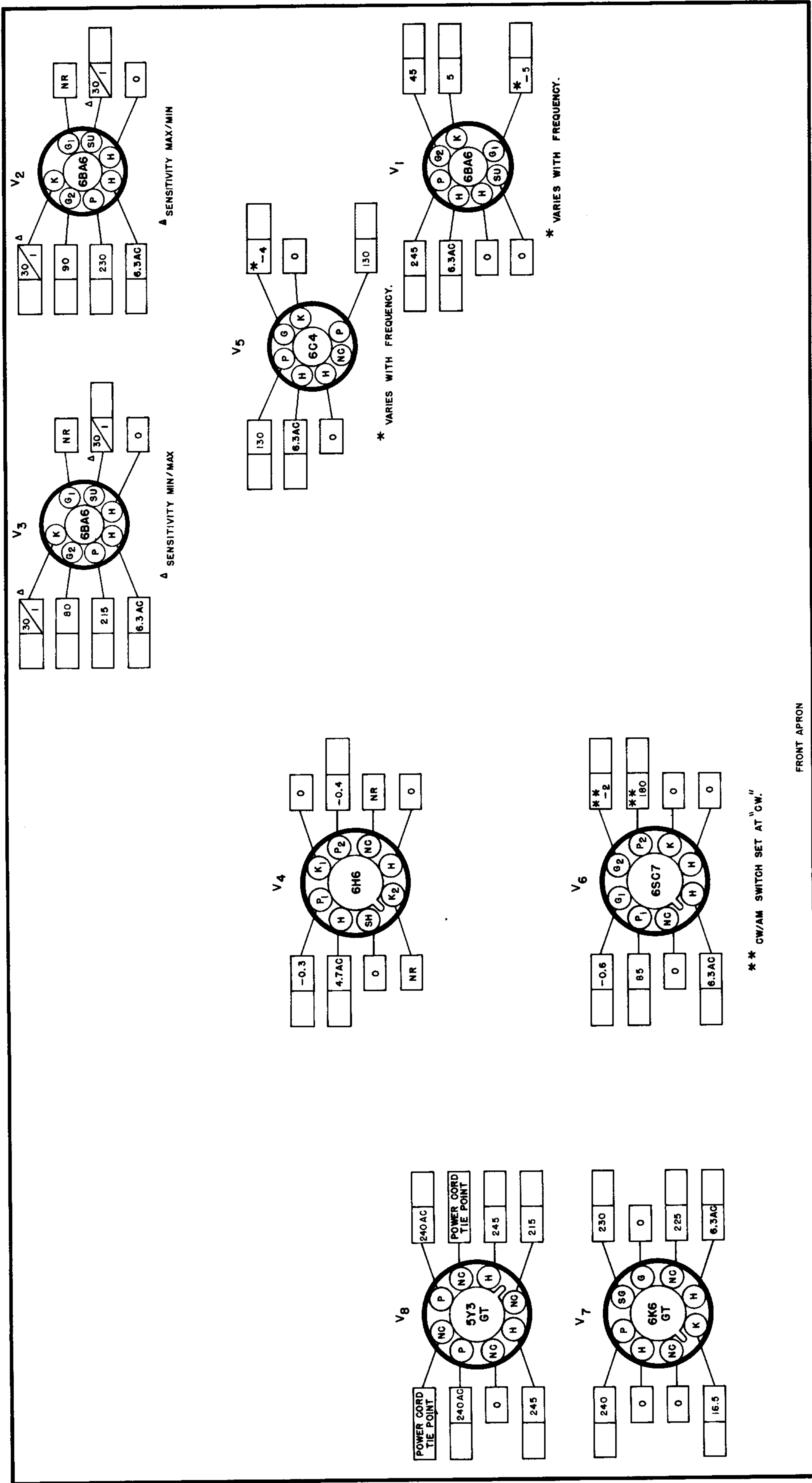

- NOTES -
1. SOCKET VIEWS ARE BOTTOM VIEWS.
 2. ALL VOLTAGES ARE MEASURED BETWEEN TUBE SOCKET TERMINALS AND CHASSIS WITH ZERO SIGNAL INPUT.
 3. LINE VOLTAGE - 117 V. AC. (60 CYCLES).
 4. ALL VOLTAGES SHOWN ARE DC. UNLESS OTHERWISE SPECIFIED.
 5. DC VOLTAGES SHOWN WERE MEASURED WITH A VACUUM TUBE VOLTMETER.
 6. READINGS TAKEN WITH STANDBY / RECEIVE SWITCH SET AT "RECEIVE"; CW/AM SWITCH SET AT "AM"; NOISE LIMITER SWITCH ON.
 7. "NC" - NO CONNECTION. (VOLTAGE SHOWN FOR THIS TERMINAL ONLY WHEN TERMINAL IS USED AS A TIE LUG).
 8. "NR" - NOT READABLE. (READING GENERALLY MEANINGLESS).
 9. [] SPACE PROVIDED FOR SERVICE METER READINGS.

Fig. 12. Tube Socket Voltage Chart

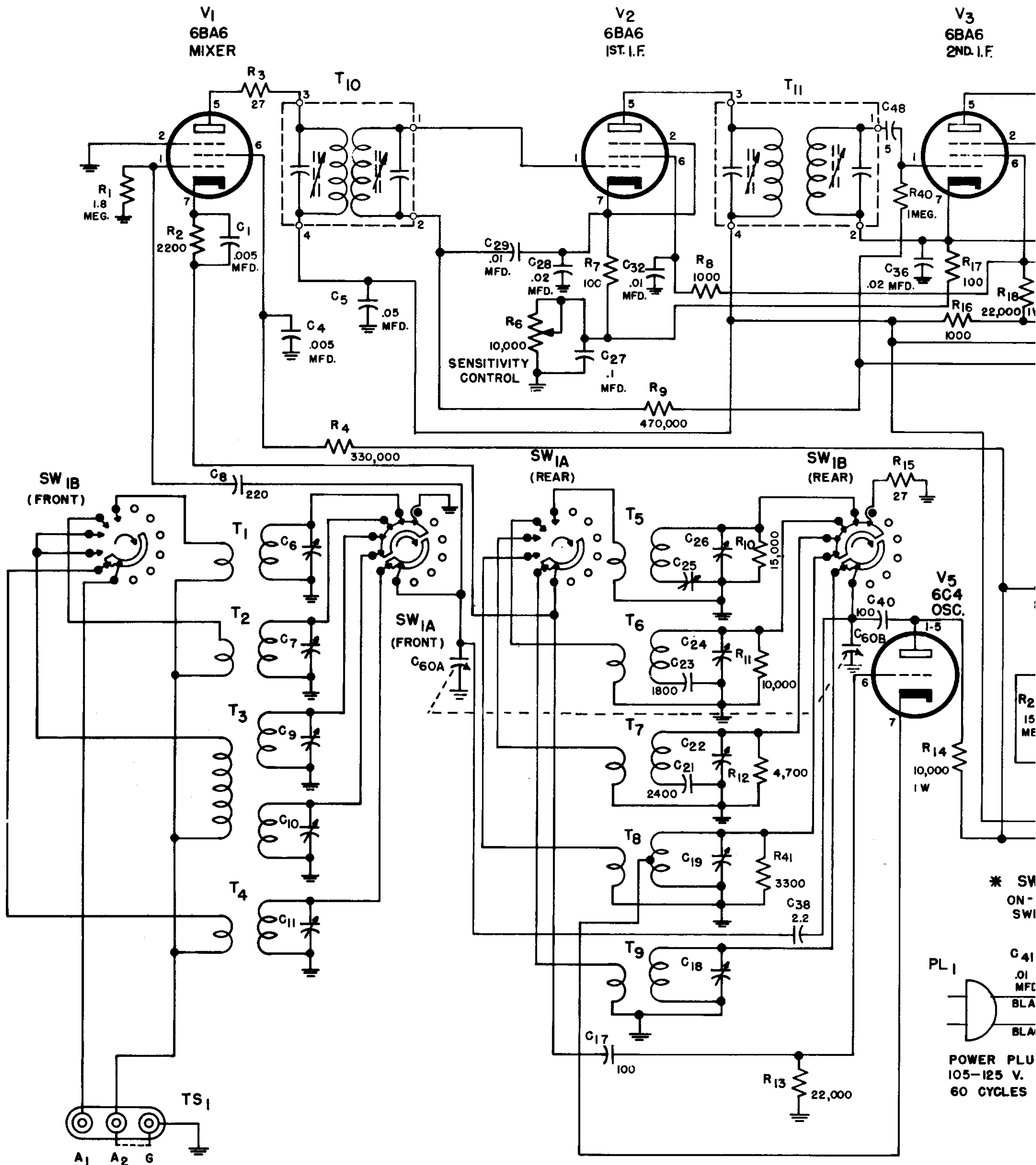

VALUES & TOLERANCES SHOWN ARE NOMINAL AND VARIATIONS MAY BE FOUND. IT IS RECOMMENDED THAT THE VALUE OF ANY REPLACEMENT CORRESPOND TO THE NOMINAL VALUE OF THE PART BEING REPLACED.

BAND SELECTOR POSITION	SWITCH SW. I RANGE
A	540-1650 KC.
B	2.5-6.6 MC.
C	6-11 MC.
D	13.5-32 MC.
E	47-55 MC.

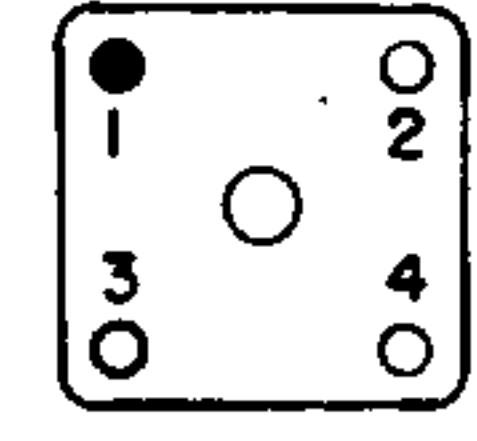

NOTE: SWITCH SHOWN IN POSITION E.

RESISTOR VA
CAPACITOR V
CHASSIS
* ON-OFF SWITCH
** PHONO SWITCH

POWER PLU
105-125 V.
60 CYCLES

LAST RESISTOR
LAST CAPACITOR

MODELS S-53A & S-53AU

RUN 2

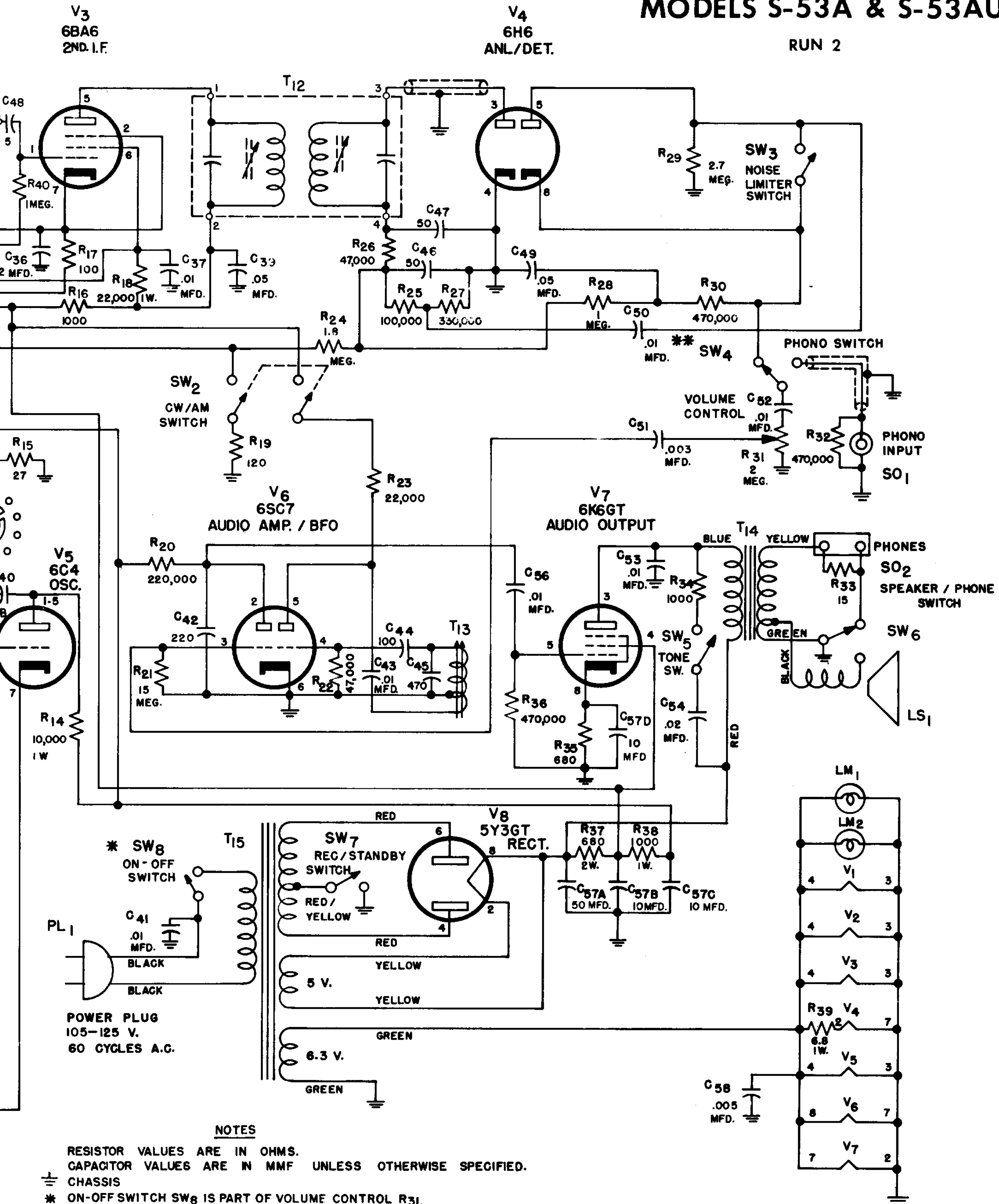

NOTES

- RESISTOR VALUES ARE IN OHMS.
- CAPACITOR VALUES ARE IN MMF UNLESS OTHERWISE SPECIFIED.
- ⊥ CHASSIS
- * ON-OFF SWITCH SW₈ IS PART OF VOLUME CONTROL R₃₁.
- ** PHONO SWITCH SW₄ IS PART OF SENSITIVITY CONTROL R₆.

89D346-C

LAST RESISTOR SYMBOL R-41
 LAST CAPACITOR SYMBOL C-60

Fig. 13. Schematic Diagram